

MULTITEL



MX170

- Commandes électro-hydrauliques proportionnelles avec la possibilité de réglage de la vitesse de tous les mouvements, aussi bien du sol que de la nacelle.
- Parallélogramme hydraulique de maintien à niveau nacelle.
- Sortie hydraulique des deux éléments télescopiques du bras.
- Chemins de câbles internes au bras.
- Clapets de blocage sur tous les mouvements.
- Pompe manuelle pour manoeuvre d'urgence.
- Arrêt coup de poing en cas de panne.
- Démarrage et arrêt du moteur depuis la nacelle.
- Dispositif interdiction sortie télescopique et rotation tourelle avec bras à repos.

- Proportional electro-hydraulic controls from both control posts.
- Hydraulic cage levelling.
- Synchronous multi-stage telescope cylinders.
- Internal hose and cable ducts.
- Hydraulic check valves on all movements.
- Emergency hand pump.
- Emergency stop on both control stations.
- Engine start-stop on both control stations.
- Telescope retainer and turret rotation blocking in transport position.

- Elektro-Hydraulische Proportionalsteuerung mit Geschwindigkeitsregelung für alle Funktionen, von Korb- und Bodenbedienung.
- Hydraulische Korbnivellierung.
- Synchron-ausfahrende Mehrstufen Teleskop-Zylinder.
- Innenliegende Kabel- und Schlauchverlegung.
- Hydraulische Sperrventile auf jede Bewegung.
- Not-Handpumpe.
- Not-Stop an beide Steuerpulte.
- Fahrzeug Start-Stop an beide Steuerpulte.
- Teleskopausfahr- und Turmdreh Sperre in Transportstellung.

- Comando elettroidraulico proporzionale con regolazione della velocità di tutti i movimenti sia dal cestello che da terra.
- Parallelismo idrostatico del cestello.
- Uscita oleodinamica degli sfili telescopici del braccio.
- Tubi e cavi installati all'interno del braccio.
- Valvole di blocco su ogni movimento.
- Pompa a mano di emergenza.
- Pulsante di arresto in caso di avaria.
- Avviamento e arresto del motore dal cestello.
- Dispositivo di interdizione uscita telescopica e rotazione torretta con braccio a riposo.

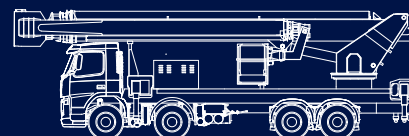
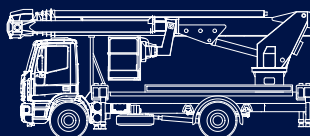
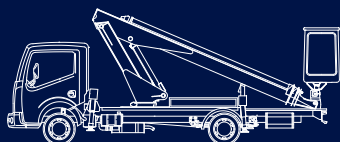



Subject to change without notice - Technische Änderungen vorbehalten!

MX170

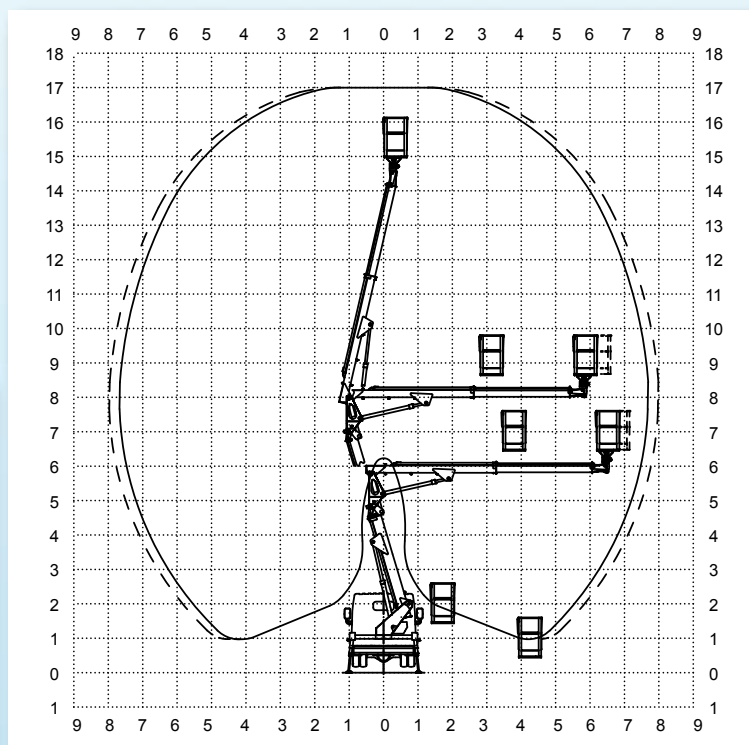
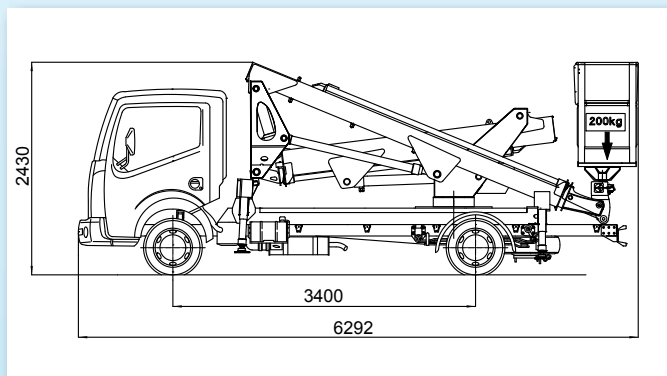

Hauteur de travail env.	Max working height	Maximale Arbeitshöhe	Altezza max di lavoro	17,00 m
Hauteur plancher nacelle env.	Maximum platform height	Maximale Plattformhöhe	Altezza piano calpestio cestello	15,00 m
Déport maxi de travail env.	Max working outreach	Maximale seitliche Reichweite	Sbraccio max di lavoro	7,60/7,95 m
Rotation de la tourelle	Turret rotation	Schwenkbereich	Rotazione torretta	360°
Rotation de la nacelle	Cage rotation	Hydraulische Korbdrehung	Rotazione idraulica del cestello	60° + 60°
Sortie télescopique des bras env.	Boom telescopic amplitude	Teleskopausschub	Escursione telescopica dei bracci	2,36 + 2,51 m
Dimensions maxi nacelle	Max cage dimensions	Max Arbeitskorbabmessungen	Dimensioni max del cestello	1,40 x 0,70 x 1,10 m
Charge utile en nacelle	Safe working load on cage	Tragfähigkeit	Portata cestello	200 kg
Dévers maxi admissible	Max admissible slope	Maximale zulässige Neigung	Pendenza ammissibile	1°

Ed. 09/2007 - Sous réserve de modification - Soggetto a modifiche senza preavviso

MULTITEL



MULTITEL PAGLIERO S.P.A.
 Strada Statale, 114
 12030 MANTA (CN) - ITALY
 Tel. +39 0175 255211
 Fax +39 0175 255255
 info@multitelgroup.com
 www.multitelgroup.com

Filiali
 Corso Piemonte, 54
 10099 S. MAURO T.S.E (TO)
 Tel. +39 011 2236792
 Fax +39 011 2236761

Via dell'Offelera, 106
 20047 BRUGHERIO (MI)
 Tel. +39 039 883393/4
 Fax +39 039 2872140

Export sales
 Jerry W. Kist
 107, rue Ten Eycken
 4850 PLOMBIERES - BELGIUM
 Tel. +32 47 755 56 67
 Fax +32 87 78 41 48
 j.kist@pagliero.com

MULTITEL INTERNATIONAL SAS
 87, rue du Morellon
 38070 ST. QUENTIN FALLAVIER - FRANCE
 Tel. +33 (0)4 74 94 63 19
 Fax +33 (0)4 74 94 46 97
 info@multitelinternational.com